

PRODUCT SPECIFICATIONS

Elkay Crosstown® 18 Gauge Stainless Steel 31-1/2" x 18-1/2" x 9", 60/40 Double Bowl Undermount Sink. Sink is manufactured from 18 gauge 304 Stainless Steel with a Polished Satin finish, Rear Center drain placement, and Full spray sides and bottom with Sides and Bottom pads.

Installation Type:	Undermount
Material:	304 Stainless Steel
Finish:	Polished Satin
Gauge:	18
Sound Deadening:	Full spray sides and bottom with Sides and Bottom pads
Number of Bowls:	2
Sink Dimensions:	31-1/2" x 18-1/2" x 9"
Bowl 1 Dimensions:	17" x 17" x 9"
Bowl 2 Dimensions:	12" x 17" x 9"
Drain Size:	3-1/2" (89mm)
Drain Location:	Rear Center
Minimum Cabinet Size:	36"
Mounting Hardware:	Part # 54300008 included
Template Included:	Yes
Cutout Template #:	1000001381

Template is available for download at [elkay.com](#). CAD software will be required to open the template.



AMERICAN PRIDE. A LIFETIME TRADITION.
Like your family, the Elkay family has values and traditions that endure. For almost a century, Elkay has been a family-owned and operated company, providing thousands of jobs that support our families and communities.

Product Compliance: ASME A112.19.3/CSA B45.4



Sinks are listed by IAPMO® as meeting the applicable requirements of the Uniform Plumbing Code®, International Plumbing Code®, and National Plumbing Code of Canada.

[Clean and Care Manual \(PDF\)](#)
[Installation Instructions \(PDF\)](#)
[Warranty \(PDF\)](#)

Installation Profile:

1/8" OVERHANG

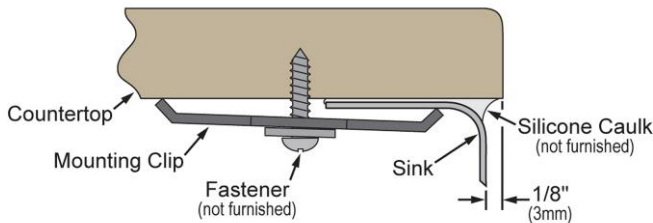

Designed to affix to the underside of any solid surface countertop.

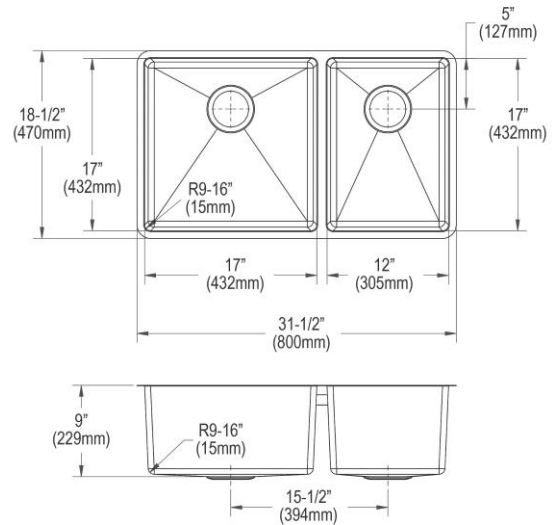

PART: _____ QTY: _____

PROJECT: _____





CONTACT: _____

DATE: _____

NOTES: _____

APPROVAL: _____

In keeping with our policy of continuing product improvement, Elkay reserves the right to change product specifications without notice. Please visit [elkay.com](#) for the most current version of Elkay product specification sheets. This specification describes an Elkay product with design, quality, and functional benefits to the user. When making a comparison of other producers' offerings, be certain these features are not overlooked.

Optional Accessories		
CTXBG1015	Elkay Crosstown Stainless Steel 10-1/2"x 15-1/2" x 1-1/4" Bottom Grid	
CTXBG1515	Elkay Crosstown Stainless Steel 15-1/2" x 15-1/2" x 1-1/4" Bottom Grid	
LKCBF17HW	Elkay Crosstown Hardwood 18" x 9-3/4" x 3/4" Cutting Board	
LKDD	Elkay 3-1/2" Drain Fitting, Deep Strainer Basket	
LK35	Elkay 3-1/2" Drain Fitting Type 304 Stainless Steel Body, Strainer Basket and Tailpiece	

In keeping with our policy of continuing product improvement, Elkay reserves the right to change product specifications without notice. Please visit elkay.com for the most current version of Elkay product specification sheets. This specification describes an Elkay product with design, quality, and functional benefits to the user. When making a comparison of other producers' offerings, be certain these features are not overlooked.